

ODX-3000

2400...3000 VA DC/AC INVERTER

GENERAL FEATURES:

Sine wave output voltage
 Suitable for motors control
 Selectable output frequency: 50/60 Hz
 Adjustable output voltage
 High input-output isolation 3000 Vrms
 Remote inhibit
 Configurable input: Reverse or Mid power
 Remote control via RS232
 Alarms by isolated relay contacts
 Remote off opto-coupled
 Optional railway version EN50155
 Fire and smoke: EN45545-2 approved



	24 Vdc 16.8 ... 30 V	36 Vdc 25.2 ... 45 V	48 Vdc 33.6 ... 60 V	72 Vdc 50.4 ... 90 V	110 Vdc 77 ... 138 V
230 Vac	ODX-3000-7413 2400 W	Available under request*	Available under request*	Available under request*	ODX-3000-7417 3000 W
400 Vac	ODX-3000-7403 2400 W	ODX-3000-7404* 3000 W	ODX-3000-7405 3000 W	ODX-3000-7406 3000 W	ODX-3000-7407 3000 W

*References subject to special MOQs and lead times



INPUT		
Input voltage range	-30, +25 % Vin nom	
Maximum input ripple	5% Vin nom (Vrms, 100 Hz)	
OUTPUT		
Nominal output voltage (Von)	See table	
Output voltage range	50 ... 230 Vac (models of 230 Vac output) via RS232 50 ... 400 Vac (models of 400 Vac output) via RS232	
Output frequency	50 / 60 Hz via DIP-switch, 5...75 Hz via RS-232	
Load regulation	< 4 %	
Line regulation	< 2 % Vin -25 % ... +25 % < 10 % Vin -30 % ... +25 % < 20 % Vin -40 % ... +40 % (100ms)	
Output waveform distortion THD	< 2 % (average of 16 samples)	
Output HF ripple	< 2.5 %	
ENVIRONMENTAL	Options B and T	Option L (Note-1)
Storage temperature	-25 ... 80 °C	-40 ... 80 °C
Operating temperature: Full load	-25 ... 55 °C (EN50155 OT1)	-40 ... 55 °C (EN50155 OT2)
Operating temperature: 62.5 % load	-25 ... 70 °C (EN50155 OT3)	-40 ... 70 °C (EN50155 OT4)
Operating temperature: 25 % load	-25 ... 85 °C (EN50155 OT5)	-40 ... 85 °C (EN50155 OT6)
Relative humidity	5 ... 95 %	
Maximum altitude	2000m at full load, 2500m at 95% of load	
Cooling	Controlled internal fan	
Shock and vibration	According to EN61373:2010 + Corr 1:2011 Category 1 class B body mounted	
MTBF (MIL-HDBK-217-E; G _b , 25 °C)	100.000 h	
EMC		
Immunity according	EN61000-6-2, EN50121-3-2	
Emissions according	EN61000-6-4, EN50121-3-2	
SAFETY	Options B and T	Option L
Dielectric strength: Input / Output	3000 Vrms / 50 Hz / 1 min	3000 Vrms / 50 Hz / 1 min
Dielectric strength: Output / PE	1500 Vrms / 50 Hz / 1 min	2500 Vrms / 50 Hz / 1 min
Dielectric strength: Input / PE	1500 Vrms / 50 Hz / 1 min	2500 Vrms / 50 Hz / 1 min
Dielectric strength: Signals (Note-2) / PE, Input	1500 Vrms / 50 Hz / 1 min	1500 Vrms / 50 Hz / 1 min
Dielectric strength: Signals (Note-2) / Output	1500 Vrms / 50 Hz / 1 min	2500 Vrms / 50 Hz / 1 min
Safety according to	EN60950-1, EN62368-1	
Fire and smoke according to	EN45545-2 (only for options T and L , railway versions)	
MECHANICAL		
Weight	< 7150 g	
PROTECTIONS		
Against overloads	Current and I ² T limited (see overload protection)	
Against over-temperature	Shutdown with auto-recovery	
CONTROL		
Output OK LED	Green	
Input OK LED	Green	
Input alarm	Open when alarm. Maximum rating: 0.16 A at 160 Vdc	
Output alarm	Open when alarm. Maximum rating: 0.16 A at 160 Vdc	
Remote OFF input	OFF: applying 15...154 Vdc (acc. to EN50155), Impedance >35kΩ	
Configurable input (reverse rotation or mid-power)	ON: applying 15...154 Vdc (acc. to EN50155), Impedance >35kΩ	

Note-1: Is not recommended to handle connectors below -25°C

Note-2: Signals include RS-232 port, control inputs and alarms outputs

ORDERING CODES

Model	Input voltage DC [V]	Input voltage range [V]	Output voltage AC [V]	Output current [A]	Active output power [W]	Appar. output power [VA]	Output peak current		Efficien. [%]	No load input current [A]
							5 s (rms) [A]	(Iopk) 10 ms [A]		
ODX-3000-7403	24	16.8 - 30	400	3.46	2400	2400	5.25	11	89	<1.58
ODX-3000-7404*	36	25.2 - 45	400	4.33	3000	3000	6.6	11	90	<1.05
ODX-3000-7405	48	33.6 - 60	400	4.33	3000	3000	6.6	11	91	< 0.79
ODX-3000-7406	72	50.4 - 90	400	4.33	3000	3000	6.6	11	91	< 0.52
ODX-3000-7407	110	77 - 138	400	4.33	3000	3000	6.6	11	92	< 0.34
ODX-3000-7413	24	16.8 - 30	230	6.00	2400	2400	9.0	19	89	<1.58
ODX-3000-7417	110	77 - 138	230	7.55	3000	3000	11.3	19	91	< 0.34

*References subject to special MOQs and lead times

ODX-3000-74 _ _ - _ _

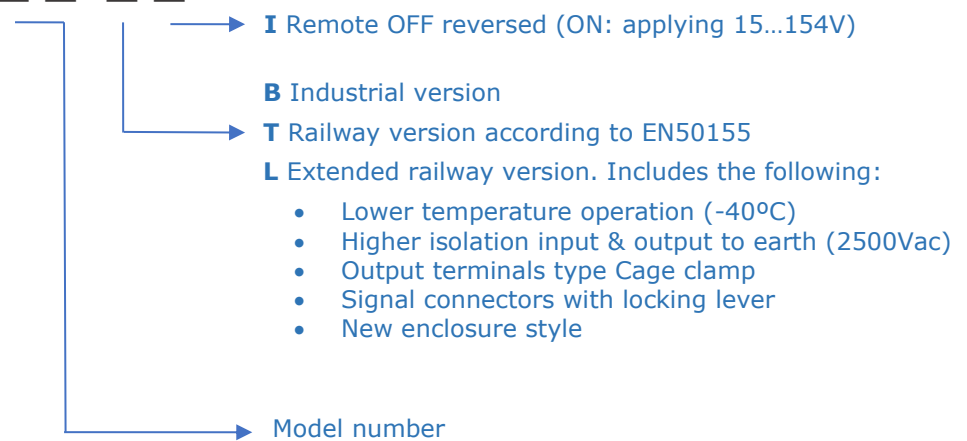

Options B and T



Option L



Accessories must be ordered in a separate order line



BLOCKS DIAGRAM

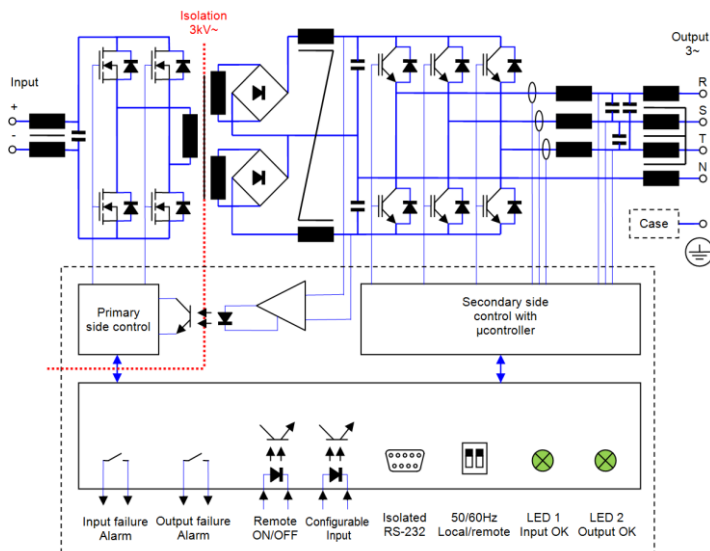

CONNECTIONS

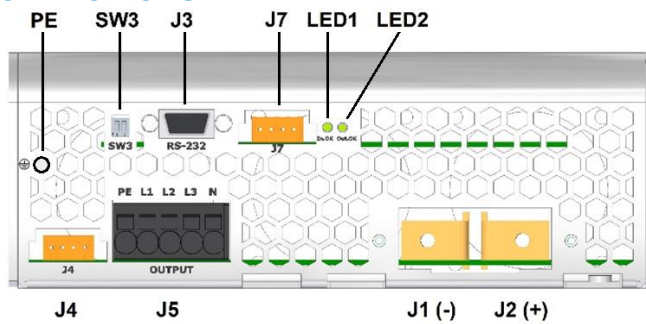

J1	-Vin	Terminals M6 (Rec. torque 6 Nm)
J2	+Vin	
PE	Protective Earth	Stud M5 (Rec. torque 3.8 Nm)
J5 - 1	Protective Earth	Cables 1.5 ... 2.5 mm ²
J5 - 2	Output R	
J5 - 3	Output S	
J5 - 4	Output T	
J5 - 5	Output Neutral	
J4 - 1	+ Configurable input	Cables 0.25 ... 1.5 mm ²
J4 - 2	- Configurable input	
J4 - 3	+ Remote ON/OFF	Option B and T Phoenix Contact MC1.5/4-G-3.81 Includes female: MC1.5/4-ST-3.81
J4 - 4	- Remote ON/OFF	
J7 - 1	Output alarm	Option L Wago 734-264 Includes female: 734-204/037-000
J7 - 2	Output alarm	
J7 - 3	Input alarm	Sub-DB9 female
J7 - 4	Input alarm	
J3 - 2	RS-232 Rx	
J3 - 3	RS-232 Tx	
J3 - 5	RS-232 GND	
J3 rest	Not connected	
SW3	Options switch	ON is position down

DESCRIPTION

The ODX-3000 consists of three phase sine-wave DC-AC inverters with galvanic isolation between input and output.

The unit allows:

- Three working modes configurable via switch SW3:

SW3-1	SW3-2	Working mode
OFF (UP)	OFF (UP)	Output frequency: 50Hz or the one programmed by default via RS232, if different from 50Hz. Output enabled by default.
OFF (UP)	ON (DOWN)	Output frequency: 50Hz or the one programmed by default via RS232, if different from 50Hz. Output disabled by default. It is enabled by the PRG3999.9 command (RS232).
ON (DOWN)	OFF/ON (UP/DOWN)	Output frequency: 60Hz.

When SW3-2 is ON (down position), the AC output must be enabled by means of the command PRG3999.9. You will find more information about this and other commands in the table "RS232 communication port" in the section below (see page 6/10).

- Shutdown applying voltage output 15 to 154 V on pins 3 and 4 of J4
- Start-up motors by means of a soft start. In the start-up, the output voltage rises linearly from 0 V to set voltage and the frequency from the initial to the set one. The start-up ramp slope may be changed via RS-232
- Set the rotation speed of a motor according to the appropriate Voltage/Frequency ratio.
- Configurable input (pin 1 and 2 of J4):
 - Reverse mode: Changing the rotation direction for the next start-up of a motor by applying voltage between 15 and 154 V
 - Mid power mode: Changing the output frequency in V/F mode from nominal to a mid-power frequency by applying voltage between 15 and 154 V.
- Monitoring the status of the input and output voltage through the contacts of two separate solid-state relays.
- Set and monitor parameters via RS-232.

The ODX-3000 is equipped with a maximum average power protection as well as maximum output peak current protection. This protects the semiconductors even when an output short-circuit occurs. It also features a disable function for input under-voltage, which allows protecting the batteries from harmful discharges.

INSTALLATION

- The unit has 4 threaded holes for the fixation on a mounting surface.
- The unit has internal fans. For an appropriate cooling, the air input and output should be free of elements that cause an air flow reduction (minimum recommended distance to other objects 50 mm).
- Make connections as shown in the figure.
- The default output frequency is 50 Hz. For 60 Hz simply actuate the DIP-switch as indicated in the figure.

For safety reasons, the following requirements must be met:

- Provide the equipment with some kind of protective enclosure that complies with the electrical safety



POWER DERATING vs AMBIENT TEMP.

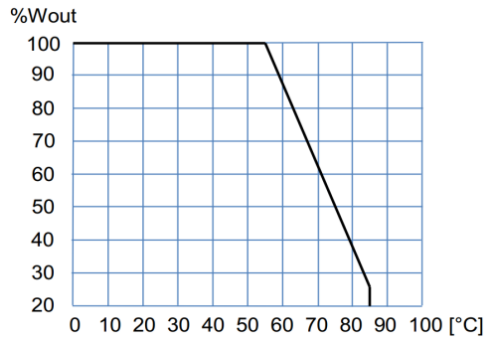

directives in effect within the country where the equipment is installed.

- Include an input fuse with a rating immediately higher than the maximum input current.
- Use cables of adequate cross-section to connect inputs and outputs. The following table lists the maximum currents and the minimum cross-sections for the cables used for each power connection.

	Input 24 V	Input 36 V	Input 48 V	Input 72 V	Input 110 V	Output 230 V	Output 400 V
Maximum current	140 A	130 A	100 A	66 A	44 A	7.55 A	4.4 A
Cable cross-section	50 mm ²	50 mm ²	25 mm ²	16 mm ²	10 mm ²	1.5 mm ²	1.5 mm ²



RS232 communication port

It is possible to control and monitor the unit via RS232 by means of an application tool named PAM. This Tool is available for download from Premium 's website.

It is also possible to control and monitor the unit directly using the protocol showed in table:

Protocol configuration: ASCII code, 9600 bauds, parity none, 8 bits, 1bit stop

Header	Function	Parameter	Returns	Explanation		
P	R	V	PTV####.■	Input voltage in Volts		
		v	PTv####.■	Input voltage ripple in Volts		
		U	PTURS=####[13]UST=####[13] UTR=####	Output voltage in Volts RMS ([13] = char 13 of ASCII code)		
		I	PTIR=####[13]IS=####[13] IT=####.■	Output current in Amps RMS ([13] = char 13 of ASCII code)		
		T	PTT####.■	Internal temperature in K		
		F	PTF####.■	Nominal output frequency in Hz		
		f	PTf####.■	Actual output frequency in Hz		
		u	PTu####.■	Actual output voltage set-point in V		
		S	PTS####.■	Inverter state 999.9 → Enabled 000.0 → Disabled 222.2 → Blocked by overload 111.1 → Blocked by overload or short-circuit		
		M	PTM####	Model number		
		R	PTR####	Firmware version		
		Other	PTE	Command not supported		
		G	1	####.■	OK / ERR	Set the low input voltage timed shutdown in V
			2	####.■	OK / ERR	Set the minimum alarm input voltage in V
	3		####.■	OK / ERR	Change the status bit (after start-up enabled with SW3 =LOCAL and disabled with SW3 =REMOTE) 999.9 → Inverter enabled 000.0 → Inverter disabled	
	4		####.■	OK / ERR	Set the output voltage in Vrms (Vo). (output must be stopped) 050.0 ≤ ####.■ ≤ 232.0 (models of 230V output) 050.0 ≤ ####.■ ≤ 405.0 (models of 400V output)	
	5		####.■	OK / ERR	Set the maximum output current in Arms 20% I _{nom} ≤ ####.■ ≤ 100% I _{nom}	
	6		####.■	OK / ERR	Set the nominal output frequency in Hz (Fo) (output must be stopped) 005.0 ≤ ####.■ ≤ 075.0	
	7		####.■	OK / ERR	Set the alarm maximum output current in Arms 0 < ####.■ ≤ 100% I _{max_warning}	
	8		####.■	OK / ERR	111.1 → Reset the inverter	
	L		####.■	OK / ERR	Set the minimum input starting voltage in Volts	
	O		####.■	OK / ERR	Set the initial frequency in the start-up (Fi) 005.0 ≤ ####.■ ≤ 075.0	
	P		####.■	OK / ERR	Set the ramp-up in increment of "N" cycles per Hz in mode V/F, frequency changes or start-up (Note-1) 001.0 ≤ ####.■ ≤ 100.0	
	Q		####.■	OK / ERR	Set the ramp-down in decrement of "N" cycles per Hz in mode V/F(Note-1) 002.0 ≤ ####.■ ≤ 100.0	
	Y		####.■	OK / ERR	* Change the working mode of the input J4-1,J4-2 111.1 → Input as reverse phase control (default) 222.2 → Input as mid-power control	
	X		####.■	OK / ERR	* Set the mid-power frequency for V/F mode by the use of input J4-1,J4-2 005.0 ≤ ####.■ ≤ 75.0	
	M		1	####.■	OK / ERR	Set a new output frequency in Hz (output must be run and not stored in memory) 005.0 ≤ ####.■ ≤ 075.0
			2	####.■	OK / ERR	Set a new output voltage in Volts (output must be run and not stored in memory) 050.0 ≤ ####.■ ≤ 232.0 (models of 230V output) 050.0 ≤ ####.■ ≤ 405.0 (models of 400V output)
		3	####.■	OK / ERR	Set a new output frequency in Hz in mode V/F (output must be run and not stored in memory) 005.0 ≤ ####.■ ≤ 075.0	
		4	####.■	OK / ERR	Changes the output phase order (output must be run and not stored in memory) 111.1 → Phase RST (direct phase) 222.2 → Phase SRT (reverse phase)	

* Parameters are only useful from version 6.0 of firmware



Note 1:

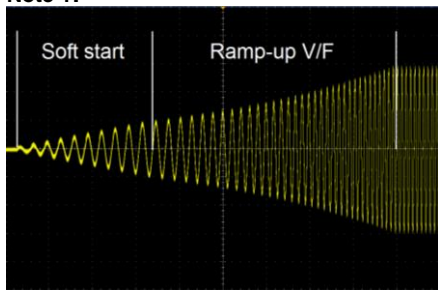

Example for N=1: start-up time = N x 1.7 s for changes from 16 Hz to 50 Hz

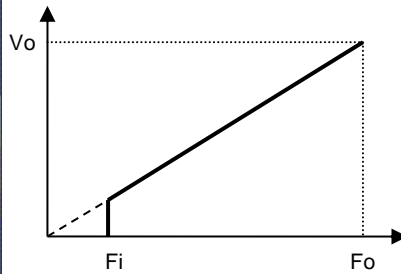

Mode V/F curve

Note 2 :

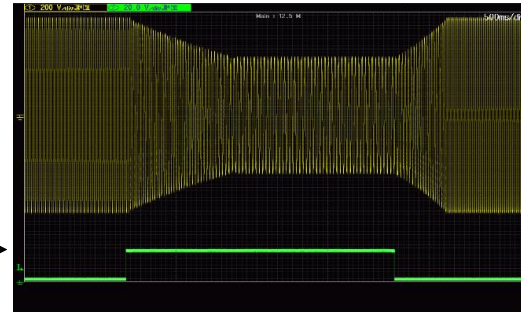

Example for change from 50Hz / 400 V to 30 Hz and 240 V with ramp-down of 2 cycles / Hz and ramp-up de 1 Cycle/Hz. Yellow: output voltage and Green: Mid-Power input signal

WORKING PARAMETERS

Thermal protection		7403...7417					
Internal warning temperature(output alarm)		82					°C
Internal shutdown temperature		98					°C
Internal restart temperature		87					°C
Internal temperature of fan start-up		45					°C
Input voltage parameters	7403 7413	7404	7405	7406	7407 7417		
High input voltage shutdown instantaneous	33.6	50.4	67.2	100.8	154.0	Vdc	
High input voltage timed shutdown (t) (Input alarm)	31.2	46.8	62.4	93.6	143.0	Vdc	
Low start-up input voltage	16.8	25.2	33.6	50.4	77.0	Vdc	
Low input voltage timed shutdown (t) (Input alarm)	<16.8	<25.2	<33.6	<50.4	<77.0	Vdc	
Low input voltage instantaneous shutdown	<14.4	<21.6	<28.8	<43.2	<66.0	Vdc	
Time to shutdown (t)	500					ms	
Output voltage parameters	7403...7407			7413...7417			
Output voltage	400			230		Vac	
Output under-voltage shutdown	< 85% of setting 1000 ms						
Warning voltage (output alarm)	< 90% of setting 200 ms						
Initial start-up frequency	16					Hz	
Soft start duration	10 cycles						
Ramp-up V/F	1 Hz/cycle						
Output current parameters	7403	7404 ... 7407	7413	7414 ... 7417			
Maximum continuous output current	3.46	4.33	6.30	7.55	A		
Warning current (output alarm)	3.46	4.33	6.30	7.55	A		
Maximum overload I ² t	See figure below						
Time between restart attempts	4000					ms	
Number of attempts of consecutive overload	5						
Working failures and reset	7403...7417						
Lock for continuous overload or internal failure	Unlimited time						
Reset time by input disconnection	> 2					min	

Configurable parameters underlined

OVERLOAD PROTECTION

Protection against overloads and short-circuits	By current limiting at Iopk By I²t . The unit shutdowns when the current-time is over the continuous operation curve	
Overload protection recovery	Every 4 seconds after shutdown, the unit tries to restart up to 5 times. If the overload persists, the unit reminds shutdown until an input reconnection .	



DIMENSIONS

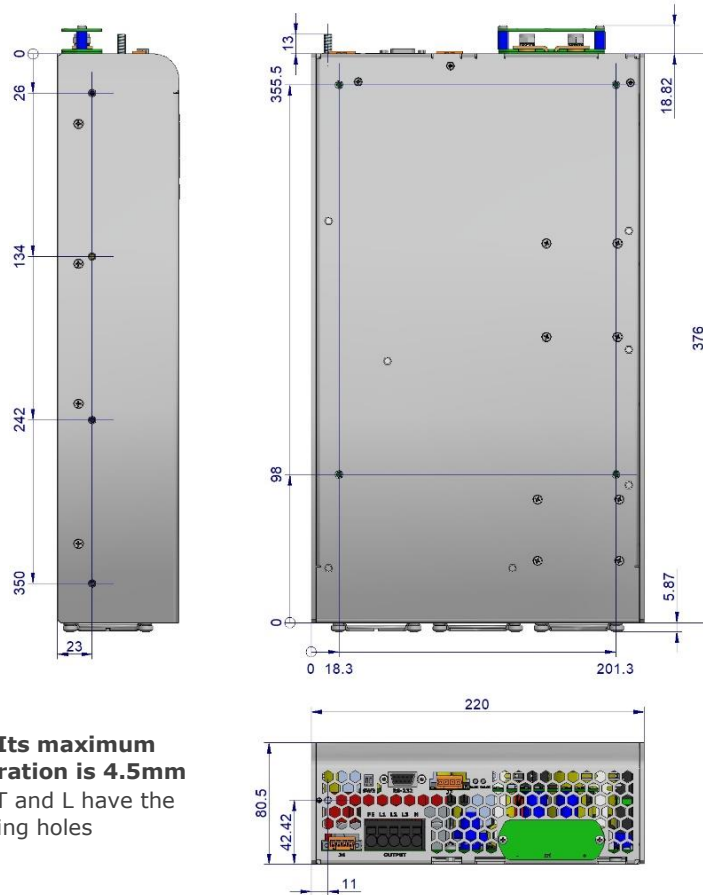

Remarks:

- The fixing holes are M4. **Its maximum allowable depth penetration is 4.5mm**
- Enclosures of models B, T and L have the same dimensions and fixing holes

ACCESSORIES

Description	Notes	CODE
Mounting brackets kit	Contains two brackets and screws	NP-9282
2U 19" rackmount tray kit	It allows to install one or two ODX-3000	NP-9353

NP-9282

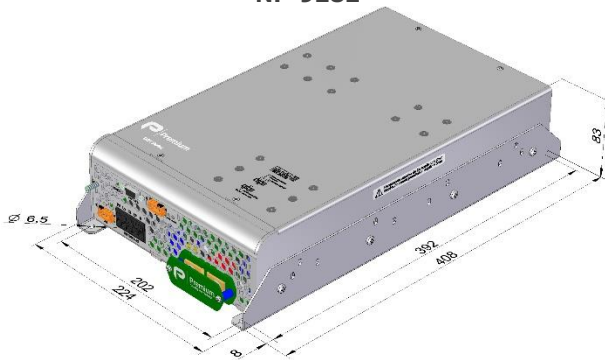

NP-9353

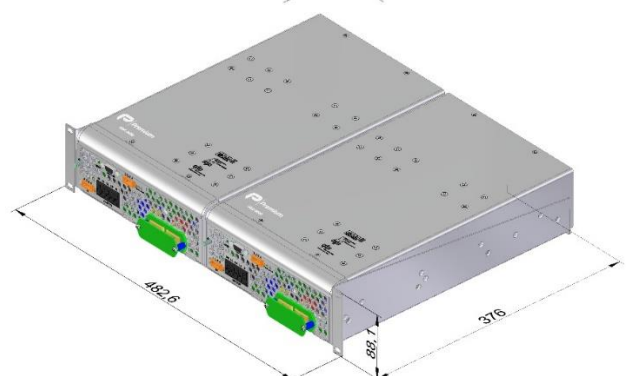
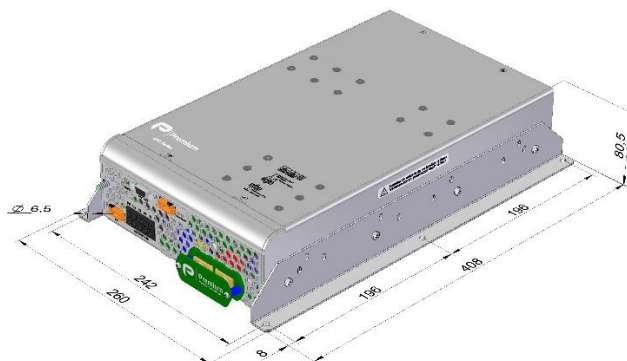
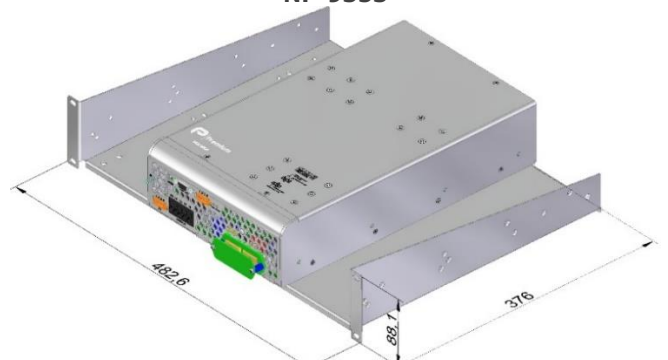



CE|UK CA EU, UKCA DECLARATION OF CONFORMITY

The undersigned, representing the following:

Manufacturer: PREMIUM, S. A.,
Address: C/ Dolors Aleu 19-21, 08908 L'Hospitalet de Llobregat, SPAIN

herewith declares that the product:

Type: DC/DC converter
Models: **ODX-3000-7403 ... 7417**

is in conformity with the provisions of the following EU directive(s):

2014/35/EU SI 2016 No 1101	Low voltage / The electrical equipment (safety) regulations
2014/30/EU SI 2016 No 1091	EMC / Electromagnetic compatibility regulations
2015/863/EU SI 2012 No. 3032	RoHS / Restriction of the use of certain hazardous substances in electrical and electronic equipment

and that standards and/or technical specifications referenced below have been applied:

EN 60950-1: 2005	Safety. Information technology equipment
EN 62368-1: 2014	Safety. Audio/video, information and communication technology equipment
IEC 61000-6-4: 2018	Generic emission standard
IEC 61000-6-2: 2019	Generic immunity standard
EN 50155: 2017*	Railway applications. Electronic equipment used on rolling stock material
EN 50121-3-2: 2016*	Railway applications. EMC Rolling stock equipment

* Optional, See annexe

CE marking year: **2013**; UKCA marking year: **2021**

Notes:

For the fulfilment of this declaration the product must be used only for the aim that has been conceived, considering the limitations established in the instructions manual or datasheet.

L'Hospitalet de Llobregat, 31-05-2021

Albert Sole
Technical Director

PREMIUM S.A. is an ISO9001 and ISO14001
certified company by **Bureau Veritas**

ANNEXE

Applicable values for the different sections of the norm EN50155: 2017																																																																		
4.3.1	Working altitude	Up to 2000m at full load Up to 2500m at 95% of load																																																																
4.3.2	Ambient temperature	For options B and T: Class OT1 (-25 to 55 °C): load < 100 % For options B and T: Class OT3 (-25 to 70 °C): load <62.5 % For options B and T: Class OT5 (-25 to 85 °C): load <25 % For option L: Class OT2 (-40 to 55 °C): load < 100 % For option L: Class OT4 (-40 to 70 °C): load <62.5 % For option L: Class OT6 (-40 to 85 °C): load <25 %																																																																
4.3.3	Switch-on extended operating temp.	ST1																																																																
4.3.4	Rapid temperature variations	H1																																																																
4.3.5	Shocks and vibrations	According EN61373:2010 + Corr 1:2011 Category 1 class B																																																																
4.3.6	EMC Electromagnetic Compatibility EN50121-3-2:2016	<table border="1"> <thead> <tr> <th>Test</th> <th>Norm</th> <th>Port</th> <th>Frequency</th> <th>Limits</th> </tr> </thead> <tbody> <tr> <td rowspan="3">Radiated emissions</td> <td rowspan="3">IEC55016</td> <td rowspan="3">Case</td> <td>30 MHz...230 MHz</td> <td>40 dB(μV/m) Qpk at 10 m</td> </tr> <tr> <td>230 MHz...1 GHz</td> <td>47 dB(μV/m) Qpk at 10 m</td> </tr> <tr> <td>1...3 GHz</td> <td>Do not apply</td> </tr> <tr> <td></td> <td></td> <td></td> <td>3...6 GHz</td> <td>Internal freq. < 108 MHz</td> </tr> <tr> <td rowspan="2">Conducted emissions</td> <td rowspan="2">IEC55016</td> <td rowspan="2">Input & output</td> <td>150 kHz...500 kHz</td> <td>99 dB(μV) Qpk</td> </tr> <tr> <td>500 kHz...30 MHz</td> <td>93 dB(μV) Qpk</td> </tr> </tbody> </table>	Test	Norm	Port	Frequency	Limits	Radiated emissions	IEC55016	Case	30 MHz...230 MHz	40 dB(μV/m) Qpk at 10 m	230 MHz...1 GHz	47 dB(μV/m) Qpk at 10 m	1...3 GHz	Do not apply				3...6 GHz	Internal freq. < 108 MHz	Conducted emissions	IEC55016	Input & output	150 kHz...500 kHz	99 dB(μV) Qpk	500 kHz...30 MHz	93 dB(μV) Qpk																																						
		Test	Norm	Port	Frequency	Limits																																																												
		Radiated emissions	IEC55016	Case	30 MHz...230 MHz	40 dB(μV/m) Qpk at 10 m																																																												
					230 MHz...1 GHz	47 dB(μV/m) Qpk at 10 m																																																												
					1...3 GHz	Do not apply																																																												
					3...6 GHz	Internal freq. < 108 MHz																																																												
		Conducted emissions	IEC55016	Input & output	150 kHz...500 kHz	99 dB(μV) Qpk																																																												
					500 kHz...30 MHz	93 dB(μV) Qpk																																																												
		<table border="1"> <thead> <tr> <th>Test</th> <th>Norm</th> <th>Port</th> <th>Severity</th> <th>Conditions</th> <th>P</th> </tr> </thead> <tbody> <tr> <td rowspan="2">Electrostatic discharge</td> <td rowspan="2">IEC61000-4-2</td> <td rowspan="2">Case</td> <td>±8 kV</td> <td>Air (isolated parts)</td> <td rowspan="2">B</td> </tr> <tr> <td>±8 kV</td> <td>Contact (conductive parts)</td> </tr> <tr> <td rowspan="4">Radiated high-frequency</td> <td rowspan="4">IEC61000-4-3</td> <td rowspan="4">X/Y/Z Axis</td> <td>20 V/m</td> <td>0.08...1.0 GHz M. 80% 1 kHz</td> <td rowspan="4">A</td> </tr> <tr> <td>10 V/m</td> <td>1.4...2.1 GHz M. 80% 1 kHz</td> </tr> <tr> <td>5 V/m</td> <td>2.1...2.5 GHz M. 80% 1 kHz</td> </tr> <tr> <td>3 V/m</td> <td>5.1...6 GHz M. 80% 1 kHz</td> </tr> <tr> <td rowspan="4">Fast transients</td> <td rowspan="4">IEC61000-4-4</td> <td>Input</td> <td>±2 kV</td> <td rowspan="4">Tr/Th: 5/50 ns</td> <td rowspan="4">A</td> </tr> <tr> <td>Output</td> <td>±2 kV</td> </tr> <tr> <td>Signal</td> <td>±2 kV</td> </tr> <tr> <td>PE</td> <td>±1 kV</td> </tr> <tr> <td rowspan="2">Surge</td> <td rowspan="2">IEC61000-4-5</td> <td>Input L to L</td> <td>±1 kV</td> <td rowspan="2">Tr/Th: 1.2/50 μs</td> <td rowspan="2">B</td> </tr> <tr> <td>Input L to PE</td> <td>±2 kV</td> </tr> <tr> <td rowspan="4">Conducted RF</td> <td rowspan="4">IEC61000-4-6</td> <td>Input</td> <td>10 V</td> <td rowspan="4">0.15...80 MHz M. 80% 1 kHz</td> <td rowspan="4">A</td> </tr> <tr> <td>Output</td> <td>10 V</td> </tr> <tr> <td>Signal</td> <td>10 V</td> </tr> <tr> <td>PE</td> <td>10 V</td> </tr> <tr> <td>Magnetic field</td> <td>IEC61000-4-8</td> <td>X/Y/Z Axis</td> <td>300 A/m</td> <td>0 Hz, 16.7 Hz, 50/60 Hz</td> <td>A</td> </tr> </tbody> </table>	Test	Norm	Port	Severity	Conditions	P	Electrostatic discharge	IEC61000-4-2	Case	±8 kV	Air (isolated parts)	B	±8 kV	Contact (conductive parts)	Radiated high-frequency	IEC61000-4-3	X/Y/Z Axis	20 V/m	0.08...1.0 GHz M. 80% 1 kHz	A	10 V/m	1.4...2.1 GHz M. 80% 1 kHz	5 V/m	2.1...2.5 GHz M. 80% 1 kHz	3 V/m	5.1...6 GHz M. 80% 1 kHz	Fast transients	IEC61000-4-4	Input	±2 kV	Tr/Th: 5/50 ns	A	Output	±2 kV	Signal	±2 kV	PE	±1 kV	Surge	IEC61000-4-5	Input L to L	±1 kV	Tr/Th: 1.2/50 μs	B	Input L to PE	±2 kV	Conducted RF	IEC61000-4-6	Input	10 V	0.15...80 MHz M. 80% 1 kHz	A	Output	10 V	Signal	10 V	PE	10 V	Magnetic field	IEC61000-4-8	X/Y/Z Axis	300 A/m	0 Hz, 16.7 Hz, 50/60 Hz	A
		Test	Norm	Port	Severity	Conditions	P																																																											
Electrostatic discharge	IEC61000-4-2	Case	±8 kV	Air (isolated parts)	B																																																													
			±8 kV	Contact (conductive parts)																																																														
Radiated high-frequency	IEC61000-4-3	X/Y/Z Axis	20 V/m	0.08...1.0 GHz M. 80% 1 kHz	A																																																													
			10 V/m	1.4...2.1 GHz M. 80% 1 kHz																																																														
			5 V/m	2.1...2.5 GHz M. 80% 1 kHz																																																														
			3 V/m	5.1...6 GHz M. 80% 1 kHz																																																														
Fast transients	IEC61000-4-4	Input	±2 kV	Tr/Th: 5/50 ns	A																																																													
		Output	±2 kV																																																															
		Signal	±2 kV																																																															
		PE	±1 kV																																																															
Surge	IEC61000-4-5	Input L to L	±1 kV	Tr/Th: 1.2/50 μs	B																																																													
		Input L to PE	±2 kV																																																															
Conducted RF	IEC61000-4-6	Input	10 V	0.15...80 MHz M. 80% 1 kHz	A																																																													
		Output	10 V																																																															
		Signal	10 V																																																															
		PE	10 V																																																															
Magnetic field	IEC61000-4-8	X/Y/Z Axis	300 A/m	0 Hz, 16.7 Hz, 50/60 Hz	A																																																													
		P = Performance criteria, L= Line, PE= Protective Earth																																																																
4.3.7	Relative humidity	Up to 95%																																																																
5.1.1.2	DC power supply range	From 0.70 to 1.25 Un continuous																																																																
5.1.1.3	Temporary DC power supply fluctuation	From 0.60 to 1.40 Un 0.1 s From 1.25 to 1.40 Un 1 s without damage																																																																
5.1.1.4	Interruptions of voltage supply	Class S1 (without interruptions)																																																																
5.1.1.6	Input ripple factor	10 % peak to peak with a DC Ripple Factor of 5 %																																																																
5.1.3	Supply change-over	0.6 Un duration 100ms (without interruptions). Performance criterion A																																																																
7.2.7	Input reverse polarity protection	By external fuse or by using accessory ACI-3000																																																																
10.7	Protective coating for PCB assemblies	Class PC2																																																																
13.3	Tests list	<table border="0"> <tr><td>1 Visual Inspection</td><td>Routine</td></tr> <tr><td>2 Performance test</td><td>Routine</td></tr> <tr><td>3 Power supply test</td><td>Routine</td></tr> <tr><td>4 Insulation test</td><td>Routine</td></tr> <tr><td>5 Low temperature storage test</td><td>Type</td></tr> <tr><td>6 Low temperature start-up test</td><td>Type</td></tr> <tr><td>7 Dry heat test</td><td>Type</td></tr> <tr><td>8 Cyclic damp heat test</td><td>Type</td></tr> <tr><td>9 Salt mist test</td><td>-</td></tr> <tr><td>10 Enclosure protection test (IP code)</td><td>-</td></tr> <tr><td>11 EMC test</td><td>Type</td></tr> <tr><td>12 Shocks and vibrations test</td><td>Type</td></tr> <tr><td>13 Equipment stress screening test</td><td>Routine: 24 h at 40 °C and load 100 %</td></tr> <tr><td>14 Rapid Temperature variation test</td><td>-</td></tr> </table>	1 Visual Inspection	Routine	2 Performance test	Routine	3 Power supply test	Routine	4 Insulation test	Routine	5 Low temperature storage test	Type	6 Low temperature start-up test	Type	7 Dry heat test	Type	8 Cyclic damp heat test	Type	9 Salt mist test	-	10 Enclosure protection test (IP code)	-	11 EMC test	Type	12 Shocks and vibrations test	Type	13 Equipment stress screening test	Routine: 24 h at 40 °C and load 100 %	14 Rapid Temperature variation test	-																																				
1 Visual Inspection	Routine																																																																	
2 Performance test	Routine																																																																	
3 Power supply test	Routine																																																																	
4 Insulation test	Routine																																																																	
5 Low temperature storage test	Type																																																																	
6 Low temperature start-up test	Type																																																																	
7 Dry heat test	Type																																																																	
8 Cyclic damp heat test	Type																																																																	
9 Salt mist test	-																																																																	
10 Enclosure protection test (IP code)	-																																																																	
11 EMC test	Type																																																																	
12 Shocks and vibrations test	Type																																																																	
13 Equipment stress screening test	Routine: 24 h at 40 °C and load 100 %																																																																	
14 Rapid Temperature variation test	-																																																																	